



## Liquid and Vacuum Pumps in the Process Industry

## Areas of application



### Liquid ring vacuum pumps

- » Distillation and separation of liquid mixtures
- » Recovery of condensates, e.g., solvents
- » Drying of bulk solids, e.g., detergent, fertiliser, salts, plastic granulates. etc.
- » Extraction of liquids, e.g., botanical extracts
- » Manufacture of cosmetic products

### Liquid pumps

- » Tempering of chemical processes
- » Heating and cooling technology
- » Pumping of aggressive, highly flammable and toxic media
- » Pumping of condensates, distillates and liquid gases



# The chemistry is right with Speck



## We are reliable partners

Speck has produced pumps for industry in Germany since 1909.

A strong customer focus, a high level of expertise, and the development of customised solutions are the main factors that set Speck apart.

As a family-run company, we think for the long term and continuously invest in our company.

Our company policy has led to above-average growth in recent decades and we have acquired the trust of our customers, who are active around the globe in many different sectors.



## We are flexible

Our customers appreciate our ability to react quickly and flexibly to changing market requirements.

We develop customised solutions for them, researching to find new, economical, and innovative solutions in the process.

We react quickly to special requests because our high level of vertical integration makes us independent of suppliers.

Our wide, modular pump system and a material selection based on the application permit us to be flexible and reliable when adapting our products to customer requirements.



## We are pleased to provide advice

Pump and system technology present complex challenges and as an expert point of contact, we support our customers in meeting them. In collaboration with customers, we select the ideal pump and specify the most suitable materials and sealing system.

We also provide advice for the optimal energy design of pumps and inform customers of the benefits of pump monitoring systems. Lifecycle cost estimates and compliance with legal requirements in the explosion-protection and TA Luft (Technical Instruction on Air Quality Control) areas round out our consulting programme.



# Speck's main facility in Roth

Design, engineering, production, assembly, and quality assurance on an area of 27,000 m<sup>2</sup>

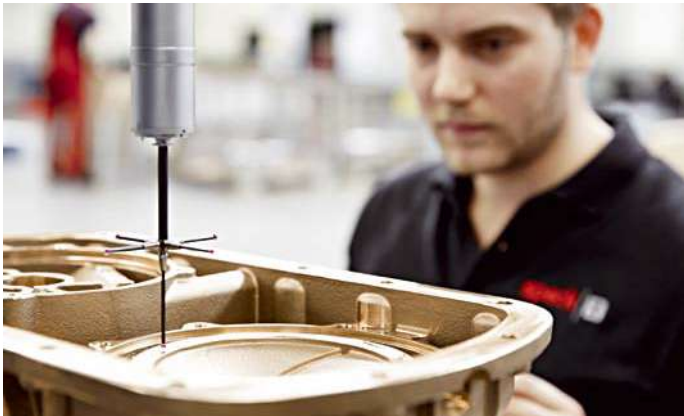

**Top:** With an extensive, modern machine park, we achieve a high level of vertical integration and maximum independence from suppliers.

**Left:** High quality standards apply throughout the production process.



**Right:** Qualified employees assemble pumps according to state-of-the-art standards.

In Roth, over 420 qualified employees manufacture around 200,000 pumps per year.

Our main facility encompasses a total building area of 27,000 square metres containing a modern machine park and high-performance systems.

In two production halls with a total area of 12,000 m<sup>2</sup>, we use over 70 modern CNC machines and processing centres to manufacture high quality pump parts.

In the 9,000 m<sup>2</sup> assembly hall, pumps and units weighing from 700 g to 1.5 t are assembled and tested.

To assist us in our work, computer-controlled, fully automated test rigs for vacuum and liquid pumps and a thermal oil test rig for temperatures up to 350 °C are available.

In 2017, we invested in a state-of-the-art logistics hall with a total area of 3,400 m<sup>2</sup> and an extensive computer-controlled small parts warehouse to improve our reaction time to customer requirements.

Speck sets high standards for its own quality management processes and is certified in accordance with DIN EN ISO 9001.

Production facilities abroad: Own factory in China since 2005. Around 100 employees produce industrial pumps on an area of 10,000 m<sup>2</sup> for the Asian market according to European quality standards there. Plus Speck has sales companies in France, Switzerland, Spain, Thailand, Taiwan, the United States of America, Australia, and Japan.

Worldwide, around 560 employees work for Speck.

# Broad product range for individual solutions

Flexibility thanks to modular systems, variant diversity, and customised designs

## Modular systems

To quickly and flexibly react to individual customer requirements, we have designed our liquid pumps and vacuum pumps as a modular system with high variant diversity.

In this way, we are able to offer pumps with the same output capacity in a variety of versions. For example, as a close-coupled pump, base plate pump, or in the lantern bracket version; with a volute or inline casing; and with a magnetic coupling or mechanical seal.

### Liquid ring vacuum pumps

We have a total of eight vacuum pump series with one and two stages in our range. Our new VHC base plate pump series was engineered with customer requirements in mind and sets new standards for individual configuration, reliability, and service-friendliness.

### Side channel pumps

We have two side channel pump series in our range: series SK according to EN 734 and series ASK with NPSH inducer stage. For magnetic coupling versions, we offer the SK series with clockwise rotation and counter-clockwise rotation. And the SK is available as a compact pump with a lantern bracket, i.e., without a base plate.

### Centrifugal pumps

The centrifugal pumps from our extensive TOE modular system are available as heat transfer pumps up to 350 °C (TOEG and TOEM) or up to 430 °C (TOEMH).

### Customised solutions

We also engineer customer-specific solutions and when working on further and new developments, have the output capacity and connecting dimensions typical of the industry in mind.

## Application-specific pumps

ATEX, TA Luft, and media such as acids, alkaline solutions, hydrocarbons, glycol, and glycerine present special requirements for pumps. In collaboration with customers, we specify the most suitable materials and sealing system.

### Casing materials and seals

We offer casings made of stainless steel, spheroidal graphite cast iron, cast steel and upon request, special alloys as well. We supply variable or casing seals according to customer specifications in a variety of materials. Static seals optionally in PTFE round section or liquid seal.

### Magnetic couplings

We manufacture our magnetic drives in-house. The start-up safety device and flushing bores used in our SmCo magnetic couplings ensure optimal separating can and shaft bearing cooling by the media to be pumped. The standard material for separating cans is 1.4571 stainless steel. And we also offer separating cans made of Hastelloy®, high-performance ceramic (ZrO<sub>2</sub>MgO) and the high-performance plastics PEEK and PPS. A wide range of sizes permits optimal energy design based on operating and working conditions.

### Mechanical seals

Our pumps are available with single-acting and double-acting mechanical seals, and cartridge seals as well. Flushing bores in the casings ensure the optimal cooling and lubrication of the mechanical seals, extending their service life as a result. Seals with sealing media and thermosiphonic systems are also available. The materials we use for the slide rings include A carbon, B carbon, SiC, Cr steel, and stainless steel. O-rings made of FKM, EPDM, FFKM and NBR are available.

## Customised solutions

We developed the innovative ChemTAL liquid ring vacuum pump for the chemical industry. It is a technically sealed pump that guarantees maximum availability and reliability thanks to its sealing system → page 7

→ Page 10



→ Page 12



→ Page 14 and 16



→ Page 15



## Vacuum pumps

- Close-coupled and base plate pumps
- » Up to 1600/1700 m<sup>3</sup>/h (50/60 Hz)
- » Up to 33 mbar abs.
- » With gas ejector up to 5 mbar
- » With mechanical seals or magnetic coupling

## Side channel pumps

- According to EN 734 or with NPSH inducer stage
- » Up to 35/42 m<sup>3</sup>/h (50/60 Hz)
- » Up to 320/400 m (50/60 Hz)
- » Media from -100 °C to +350 °C
- » PN 40
- » With mechanical seals or magnetic coupling

## Centrifugal pumps

- Volute and inline casing pumps
- » Up to 550/460 m<sup>3</sup>/h (50/60 Hz)
- » Up to 100 m (50/60 Hz)
- » Media from -100 °C to +400 °C
- » With mechanical seals or magnetic coupling
- Horizontal section-type pumps
- » Up to 110/125 m<sup>3</sup>/h (50/60 Hz)
- » Up to 600/400 m (50/60 Hz)
- » Up to PN 63
- » With mechanical seal

## Regenerative turbine pumps

- Close-coupled pumps with magnetic coupling
- » Up to 200 l/min respectively 12 m<sup>3</sup>/h (50/60Hz)
- » Up to 90 m
- » Media from -100 °C to +350 °C



# Magnetic coupling design

Reliability and low power consumption thanks to optimal size, material selection, and design

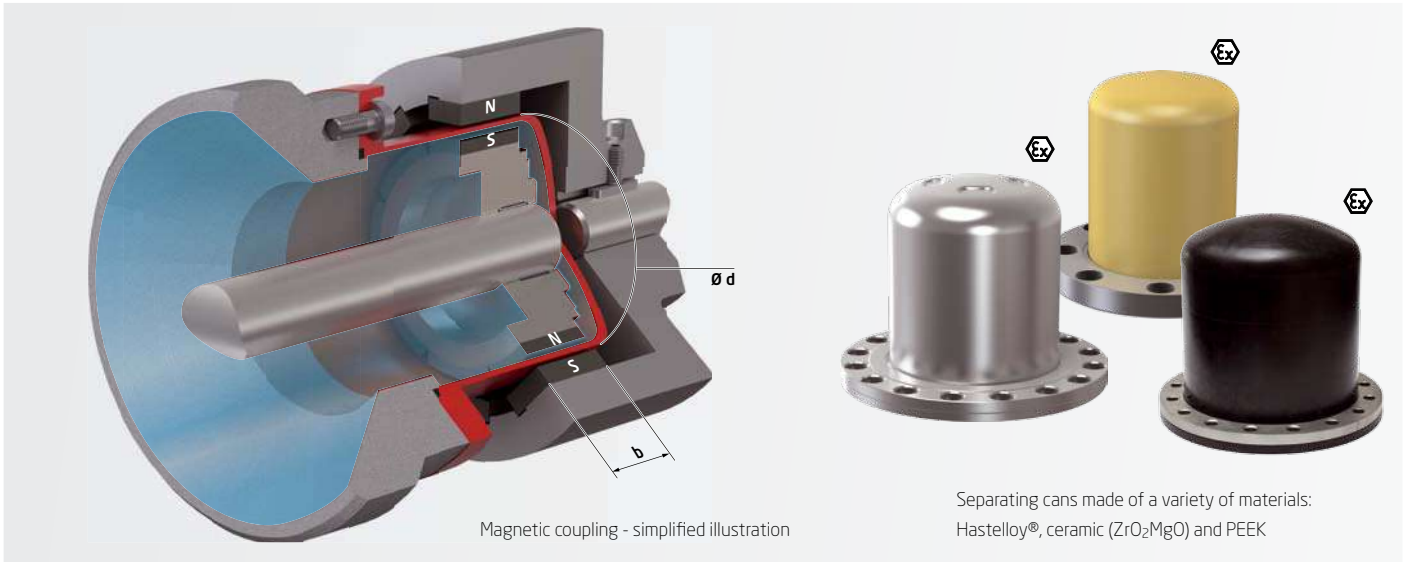

Magnetic coupling - simplified illustration

Separating cans made of a variety of materials: Hastelloy®, ceramic (ZrO<sub>2</sub>MgO) and PEEK



Magnetic couplings are used ever more frequently due to their high reliability and freedom from maintenance.

In our magnetic couplings, flushing bores ensure that the separating can and shaft bearings are cooled by the media to be pumped. And start-up safety devices prevent sparks and metallic separating can breakage. The size and material also play key roles when it comes to economical, safe design.

## Dimensioning key for energy optimisation

The right combination of size and magnetic coupling diameter has a direct effect on power consumption, which is why we have developed a wide, finely graduated range of magnetic couplings.

This enables us to provide you with a design with the optimal power for your operating conditions and operating point.

Magnetic couplings with five separating can diameters of DN 60 to DN 165 and nine magnet lengths ranging from 40 mm to 120 mm with which torques of 10 Nm to 500 Nm can be transmitted are available.

## Stainless steel 1.4571, Hastelloy®, ceramic, PEEK and PPS

Depending on customer requirements, we can supply magnetic couplings with separating cans in a variety of materials.

Hastelloy® C4 has high media resistance, permitting pressure of up to PN 100 and temperatures of up to 350 °C.

High-quality ceramic separating cans made of ZrO<sub>2</sub>MgO up to PN 40 are available at Speck. They permit temperatures of up to 400 °C, prevent eddy current loss and avoid additional energy input into the medium. With an electrically conductive coating, they also fulfil ATEX requirements. Ceramic separating cans are available for liquid pumps and the ChemTAL vacuum pump.

Separating cans made of PEEK or PPS high-performance plastic are suitable for temperatures up to 130 °C. As with ceramic separating cans, they prevent eddy current loss and heat input into the medium. With an electrically conductive coating, they also fulfil ATEX requirements.

PEEK and PPS separating cans in dry-running couplings are also ideal for use with critical media and processes such as in the VHCM/ChemTAL series specially developed for the chemical industry. For more information, see pages 7 and 11

## Eddy current loss and heat input

The magnetic fields of the magnetic coupling generate eddy currents in the separating can. The energy this consumes is directly input into the medium as heat, which can be critical in the cases of ATEX applications and media near vapour pressure. At the same time, eddy current loss also increases the pump's total energy requirement.

## The great influence of length, diameter and material

$$P_w = \frac{n^2 \cdot b \cdot S \cdot d^3 \cdot B^2}{W}$$

- P<sub>w</sub> = Eddy current loss
- n = Speed
- b = Magnet length
- S = Thickness of separating can wall
- d = Ø of separating can
- B = Residual magnetism
- W = Spec. electr. resistance

The formula demonstrates that the diameter of the magnetic coupling creates eddy current loss P<sub>w</sub> in the third power and therefore has a significant impact. In other words, magnetic couplings with small diameters and longer magnets are the better choice for saving energy. When magnetic couplings are too large, energy consumption increases. However, the specific electrical resistance of the separating can material has an even more pronounced

effect on the level of eddy current loss. For Hastelloy® C4 in comparison to stainless steel 1.4571 it equals only 60% and is negligible for PEEK, PPS and ceramic.

Material	Spec. electr. Resistance W in Ω mm <sup>2</sup> /m
1.4571	0.75
Hastelloy® C4	1.25
PEEK/PPS	> 10 <sup>9</sup>
Ceramic (ZrO <sub>2</sub> MgO)	> 10 <sup>10</sup>

## Pump monitoring

Higher reliability and longer maintenance intervals

Pump monitoring has many benefits to operators. It means greater reliability because impermissible process conditions can be detected immediately or early on. And it ensures high system availability thanks to the early detection of wear, permitting the proactive planning of maintenance intervals. Upon customer request, we supply a range of monitoring sensors that can be combined with each other.

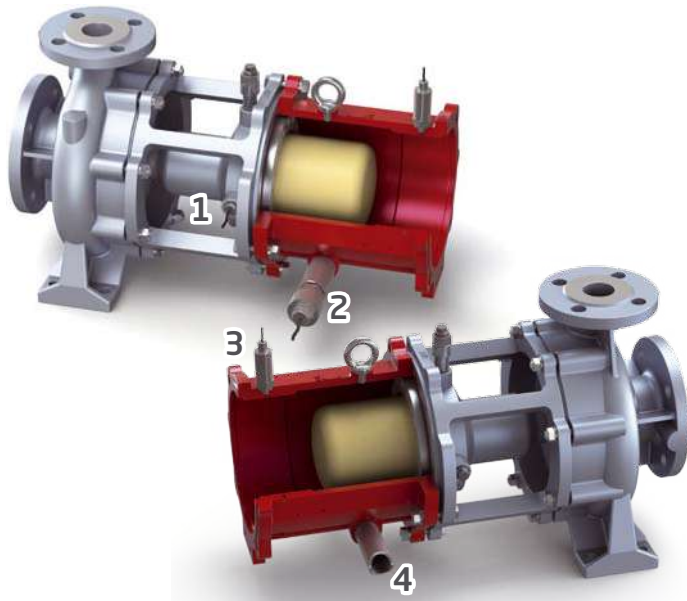

Cutaway model of a TOEMH heat transfer pump for media up to 400 °C

- 1 PT 100 temperature sensor - here at bearing bracket and at the bracket on other pumps
- 2 Leak sensor at the lowest point of the bracket
- 3 Vibration sensor
- 4 Leak outlet (pipe) at the lowest point of the bracket

### Temperature monitoring for separating cans

The PT 100 temperature sensor monitors the exterior temperature of the separating can for pumps with metal separating cans. For pumps with ceramic separating cans (TOEMH), it monitors the medium temperature of sleeve bearings lubricated with medium. This sensor is available in a standard version or ATEX certified with or without SIL/IPL2 certification.

### Leak monitoring for separating cans in liquid pumps

The leak sensor at the lowest point of the bracket guarantees an immediate reaction in the event of separating can breakage. In addition, a leak outlet can be connected to safely drain the leak from the bracket.

### Monitoring of bearings

Vibration sensors for detecting wear in roller and sleeve bearings are also available.

### Monitoring of mechanical seals

We offer systems for the continuous leak monitoring of mechanical seals for some pumps. They enable users to detect mechanical seal failure early on.

## ATEX and TA Luft

Reliable solutions for critical applications

For toxic, flammable, and explosive media, we configure our pumps such that they reliably fulfil the legal requirements for TA Luft and the explosion protection regulations.

### Synthesis of design solutions

The synthesis of various design solutions in our products ensures that they fulfil all legal requirements. This includes technically sealed pumps, magnetic couplings with start-up safety devices and flushing bores, monitoring systems for separating cans and bearings, inerting equipment, and other components.

### VHCM/ChemTAL special development

The special liquid ring vacuum pump developed for the chemical industry is an excellent example. In it, we combined a technically sealed pump with mechanical seals and a dry-running magnetic coupling. The completely sealed pump ensures high operational reliability in conjunction with pump monitoring systems.

### ATEX

Our pumps are certified as follows:

- » Liquid pumps with mechanical seal: ATEX II 2G
- » Liquid pumps with magnetic coupling: ATEX II 2G
- » Vacuum close-coupled pumps: ATEX 2G/2G, 2G/2D
- » Vacuum pumps with base plates: ATEX 1G (+H2)/2G, 2G/2G, 2G/2D



VHCM (ChemTAL) liquid ring vacuum pump as per TA Luft with a pump monitoring system used for solvent recovery.

# Pump configuration with software

Perfect for production engineers and plant planners – liquid pump configuration with SPAIX

We make SPAIX available to our authorised customers so they can configure and pre-select centrifugal and side channel pumps.

The web-based software accesses a continuously maintained database to offer a variety of selection parameters for design, sealing systems, hydraulic systems, operating conditions and media. Users can select either German or English as the language.

Production engineers and plant planners can use SPAIX to design new plants.

After consultation with Speck, users can also check currently installed pumps for which the plant parameters have changed: for example, after medium changeover or new operating conditions.

Executed configurations can be saved as a project and exported as a PDF with one click. The PDF files contain a technical data sheet, a dimensional drawing and characteristic curves with power consumption and NPSH values.

When the order is received, Speck also checks the customer's pre-selections to ensure that the project requirements have been satisfied.

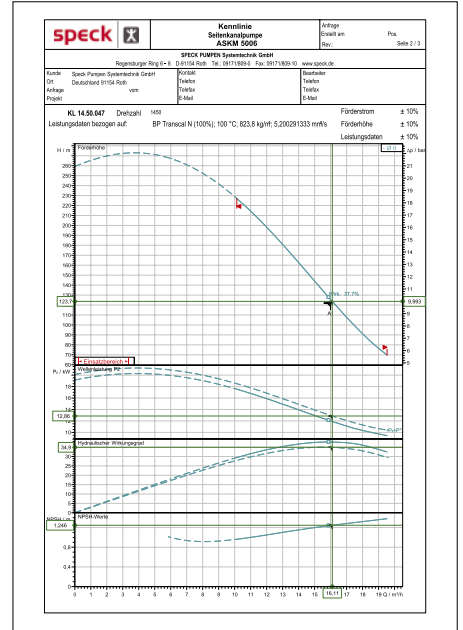

Simple documentation with one click – characteristic curve from SPAIX. Dimensional drawings and technical data sheets are created just as quickly.

# Pump lifecycle costs

Energy costs make up the largest portion

Until a pump is finally replaced, the greatest portion of the costs is generated during operation. This is why consultation during procurement is very important. We are pleased to support our customers in the configuration and determination of the lifecycle costs of energy-efficient, maintenance-friendly pumps.

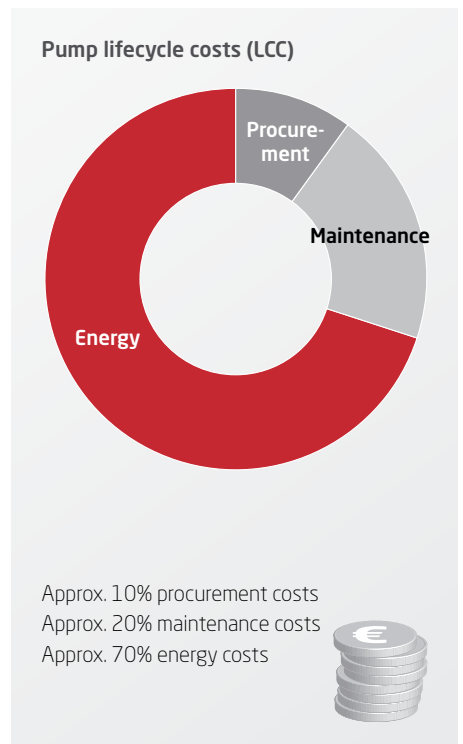

The most important costs of a pump over the entire lifecycle.



## Quality assurance and tests

Modern, fully automated and computer-controlled test rigs in the Speck plant



At our main plant in Roth, we have invested in modern, high-performance and fully automated computer-controlled test rigs for liquid and vacuum pumps.

With the test rigs for liquid pumps, measurements with total heads of up to 400 m and flow rates of up to 750 m<sup>3</sup>/h can be taken. On the thermal test rig, we can carry out tests up to 350 °C.

For liquid ring vacuum pumps, tests with suction pressure of up to 5 mbar and suction capacity of up to 2,000 m<sup>3</sup>/h are possible.



### Standard tests

#### Hydraulic tests for vacuum pumps

The characteristic curves are measured with water at nominal speeds as per DIN 28431.

The suction capacity tolerance is -10%, that of the required output is +10%. For deviating operating conditions (e.g., deviating data of the gas or operating liquid to be pumped, liquid carry over, pumping of gas-vapour mixtures), the characteristic curves will change.

#### Gas pressure test for liquid pumps

The gas pressure test is used to document that the components are not leaking. All components to which pressure is applied, such as pressure and suction casings, variable seals and mechanical seal casings are tested. The test is carried out with forming gas.

#### Hydrostatic pressure test

The hydrostatic pressure test is used to prove strength of the components and that the pump is not leaking. The fully assembled pump is tested. If pressure tests according to other criteria are required, they must be listed in the enquiry.

### Tests according to customer specifications

#### Hydraulic tests for liquid pumps

Measurements of centrifugal pumps as per EN ISO 9906, class II, acceptance class 2B, March 2013 edition. For all other liquid pumps, the characteristic curves for pumping water with a temperature of 20 °C at nominal speed apply.

#### NPSH test for liquid pumps

In this test, the suction-side pressure is gradually reduced until the decrease in the total head reaches 3% at a constant flow. At least four flows are evaluated that are spread appropriately over the permitted operating area.

#### Vibration measurement

Vibration measurement as per EN ISO 5199, 2002 edition – The vibration values are determined radially and vertically at the bearing casing for each measured operating point at nominal speed.

#### Temperature measurement

The temperature is measured at the bearing at operating temperature. The operating temperature and the ambient temperature at each measured operating point are documented.

#### Noise measurement

Extent and procedure in coordination with the customer.

# Liquid ring vacuum pumps with mechanical seal and magnetic coupling



Speck offers a total of 8 different series, each with its own product features and benefits.

## Features and benefits

- » Can be used universally for compressing practically all gases and vapours
- » Constant suction performance for different applications
- » Liquid carry over at a constant vacuum
- » Carry over of non-abrasive solids such as powder or dusts to a limited extent

- » Pumping explosive gases, e.g., hydrogen or flammable and toxic media
- » Oil-free vacuum generation, i.e., no oil in the medium or in the exhaust air
- » Use of condensed process medium as the operating liquid
- » Optional pump monitoring (sensors) available



## Series V

Single-stage close-coupled pumps with mechanical seal

### Performance range

- » Up to 370/445 m<sup>3</sup>/h (50/60 Hz)
- » Up to 33 mbar abs.
- » With gas ejector up to 5 mbar abs.

### Design

- » Modular system with 9 sizes
- » Stainless steel, grey cast iron, non-ferrous metal
- » With flap valves made of PTFE
- » Single-acting mechanical seal

### Product benefits

- » ATEX 2G/2G, 2G/2D
- » Can be used universally
- » Durable, proven technology

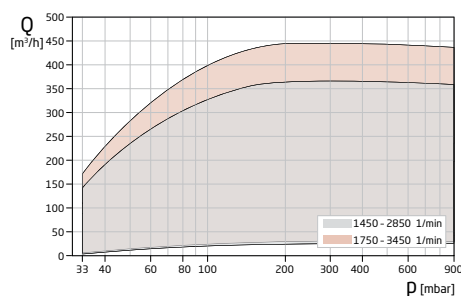

## Series VG

Single-stage close-coupled pumps with mechanical seal

### Performance range

- » Up to 200/245 m<sup>3</sup>/h (50/60 Hz)
- » Up to 40 mbar abs.

### Design

- » Modular system with 6 sizes
- » Stainless steel
- » Valve-free
- » Single-acting mechanical seal

### Product benefits

- » ATEX 2G/2G, 2G/2D
- » Thread and flange versions available
- » Virtually free of dead space for fewer deposits

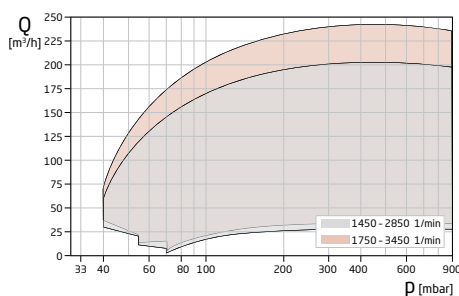

## Series VU

Single-stage base plate pumps with mechanical seal or with magnetic coupling upon request

### Performance range

- » Up to 1550/1900 m<sup>3</sup>/h (50/60 Hz)
- » Up to 120 mbar abs.

### Design

- » Modular system with 12 sizes
- » Stainless steel, grey cast iron, non-ferrous metal
- » Some with flap valves made of PTFE
- » Single-acting or double-acting mechanical seal
- » Magnetic coupling upon request

### Product benefits

- » ATEX 1G (+H2)/2G, 2G/2G, 2G/2D and TA Luft
- » Durable, proven technology

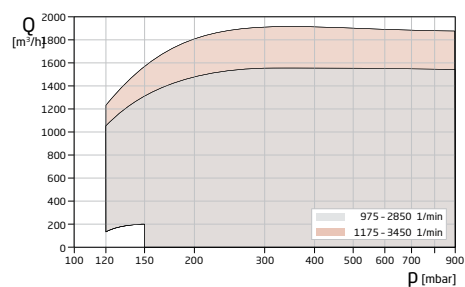

## Plant construction and vacuum systems

### Applies for all series:

- » Operating liquid up to 80 °C
- » Gas to be extracted:
  - Dry up to 200 °C
  - Saturated up to 100 °C

### Typical applications

- » Distillation and separation of liquid mixtures
- » Recovery of condensates, e.g., solvents
- » Drying of bulk solids, e.g., detergent, fertiliser, salts, etc.
- » Extruder degasification in the plastics industry
- » Vacuum generation in evaporation plants



### Series VZ

**Two-stage pumps with and without base plate, with mechanical seal or magnetic coupling**

#### Performance range

- » Up to 185/220 m³/h (50/60 Hz)
- » Up to 33 mbar abs.
- » With gas ejector up to 5 mbar abs.

#### Design

- » Modular system with 5 sizes
- » Stainless steel, grey cast iron, non-ferrous metal
- » Valve-free
- » Single-acting or double-acting mechanical seals
- » Magnetic coupling

#### Product benefits

- » ATEX 1G (+H2)/2G, 2G/2G, 2G/2D and TA Luft
- » Durable, low-noise technology

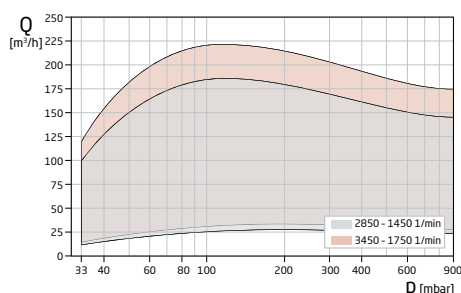

### Series VHC/VHCM

**New**

**Two-stage base plate pump with mechanical seal (VHC) or magnetic coupling (VHCM/ChemTAL)**

#### Performance range

- » Up to 1600/1700 m³/h (50/60 Hz)
- » Up to 33 mbar abs.
- » With gas ejector up to 5 mbar abs.

#### Design

- » Modular system with 11 sizes
- » Stainless steel, grey cast iron or special alloys
- » Valve-free
- » VHC: Single-acting or double-acting mechanical seals
- » VHCM/ChemTAL: Combination of mechanical seals and dry-running magnetic coupling with PEEK or ceramic separating can

#### Product benefits

- » ATEX 1G (+H2)/2G, 2G/2G, 2G/2D and TA Luft
- » Reliable and service-friendly

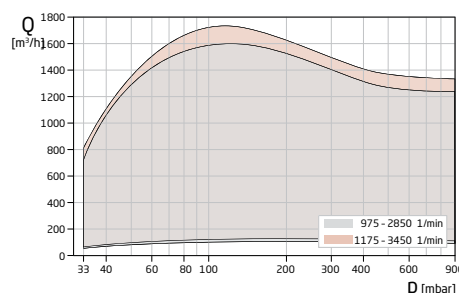

### Plant construction and vacuum systems

**Plants for the chemical industry according to the highest global industry standards**

One of Speck's well-known partner companies is responsible for the design and project planning of ready-to-connect vacuum systems for special process industry applications.

#### For example:

- » Vacuum supply plant with four magnetic-coupled liquid ring vacuum pumps that are controlled on four different pressure levels.
- » Including liquid separator, heat exchanger, measurement and control technology.
- » Use of type VHCM/ChemTAL stainless steel pumps from Speck with solvent-resistant seal materials

#### Benefits

- » Design as per TA Luft
- » ATEX to Zone 0 and temperature class T6
- » Customers benefit from Speck's expertise and its collaboration with partner companies



# Side channel pumps with mechanical seal and magnetic coupling



With its well-planned SK/ASK modular system, Speck offers side channel pumps in a wide range of variants.

## Features and benefits

- » Suitable for pure liquids without abrasive contaminants or solid content
- » Ideal for pumping, filling and draining under difficult physical conditions
- » Also transports gas and is self-priming

- » Higher total heads and higher pressures thanks to multi-stage versions
- » Steep characteristic curves for excellent control
- » Optional pump monitoring (sensors) available



Series SKG-LL

**Side channel pumps with mechanical seal**

### Performance range (1-8 stages)

- » Up to 320/400 m and 35/42 m<sup>3</sup>/h (50/60 Hz)
- » Media up to 180 °C
- » PN 40

### Design

- » Single-acting mechanical seal
- » 2 rolling bearings (outside)
- » Base plate
- » Spheroidal graphite cast iron/stainless steel/bronze
- » Casing and hydraulics as per EN 734

### Product benefits

- » ATEX II 2G
- » Proven pump with universal applications
- » Left and right direction of rotation available

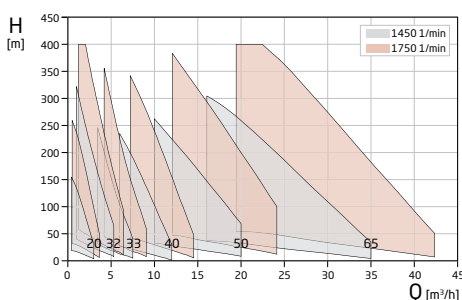

Series SKG-LO

**Side channel pumps with mechanical seal**

### Performance range (1-8 stages)

- » Up to 320/400 m and 35/42 m<sup>3</sup>/h (50/60 Hz)
- » Media up to 180 °C
- » PN 40

### Design

- » Single-acting or double-acting mechanical seal
- » 1 rolling bearing (outside) and 1 sleeve bearing (inside)
- » Base plate
- » Spheroidal graphite cast iron/stainless steel/bronze
- » Casing and hydraulics as per EN 734

### Product benefits

- » ATEX II 2G and TA Luft
- » Proven pump with universal applications
- » Left and right direction of rotation available

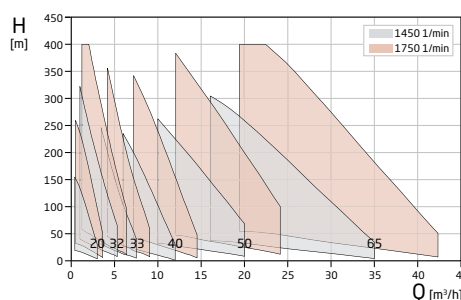

Series SKG-LA

**Side channel pumps with mechanical seal**

### Performance range (1-3 stages)

- » Up to 120/175 m and 35/42 m<sup>3</sup>/h (50/60 Hz)
- » Media up to 180 °C
- » PN 40

### Design

- » Single-acting or double-acting mechanical seal
- » 1 rolling bearing (outside) and 1 sleeve bearing (inside)
- » Bracket version
- » Spheroidal graphite cast iron/stainless steel/bronze
- » Casing and hydraulics as per EN 734

### Product benefits

- » ATEX II 2G and TA Luft
- » Proven pump with universal applications
- » Left and right direction of rotation available
- » Compact

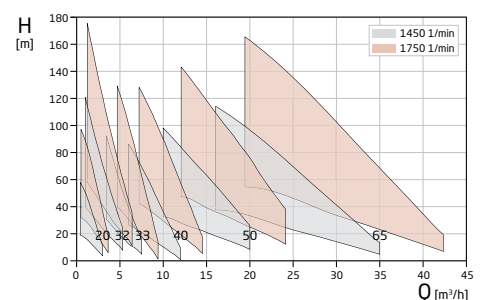

**Typical applications**

- » Pumping of aggressive, highly flammable and toxic media
- » Recovery of condensates, e.g., solvents
- » Pumping of condensates, distillates, liquid gases and low-boilers



Series ASKG

**Side channel pumps with mechanical seal**

**Performance range (1-8 stages)**

- » Up to 320/400 m and 35/42 m<sup>3</sup>/h (50/60 Hz)
- » Media up to 180 °C
- » PN 40

**Design**

- » Single-acting or double-acting mechanical seal
- » 1 rolling bearing (outside) and 1 sleeve bearing (inside)
- » Base plate
- » Spheroidal graphite cast iron/stainless steel/bronze

**Product benefits**

- » ATEX II 2G and TA Luft
- » Suitable for pumping under physically unfavourable suction-side conditions
- » Suitable for pumping close to the boiling point

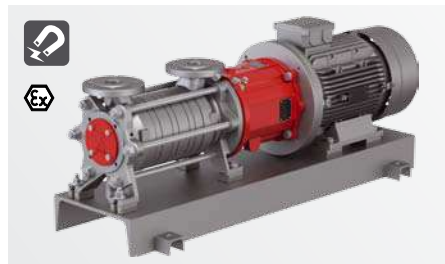
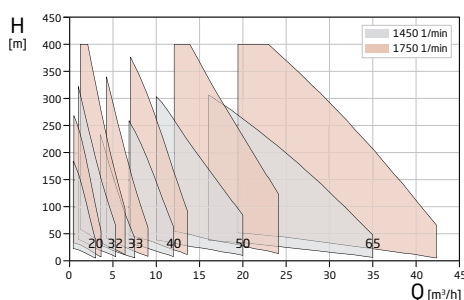

Series SKM

**Side channel pumps with magnetic coupling**

**Performance range (1-8 stages)**

- » Up to 320/400 m and 35/42 m<sup>3</sup>/h (50/60 Hz)
- » Media from - 100 °C to + 350 °C (depending on materials and version)
- » PN 40

**Design**

- » Magnetic coupling
- » 2 sleeve bearings (inside)
- » Base plate
- » Spheroidal graphite cast iron/stainless steel/bronze
- » Casing and hydraulics as per EN 734

**Product benefits**

- » ATEX II 2G and TA Luft
- » Magnetic coupling with start-up safety device
- » Proven pump with universal applications
- » Left and right direction of rotation available

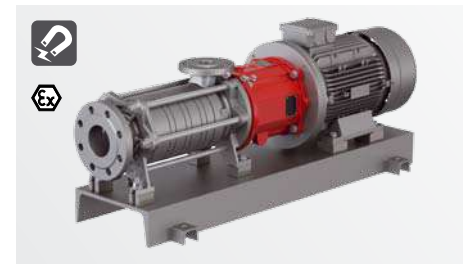
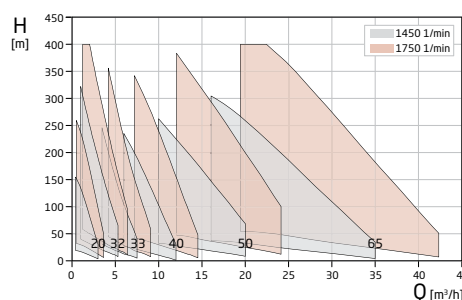

Series ASKM

**Side channel pumps with magnetic coupling**

**Performance range (1-8 stages)**

- » Up to 320/400 m and 35/42 m<sup>3</sup>/h (50/60 Hz)
- » Media from - 100 °C to + 350 °C (depending on materials and version)
- » PN 40

**Design**

- » Magnetic coupling
- » 2 sleeve bearings (inside)
- » Base plate
- » Spheroidal graphite cast iron/stainless steel/bronze

**Product benefits**

- » ATEX II 2G and TA Luft
- » Magnetic coupling with start-up safety device
- » Suitable for pumping under physically unfavourable suction-side conditions
- » Suitable for pumping close to the boiling point

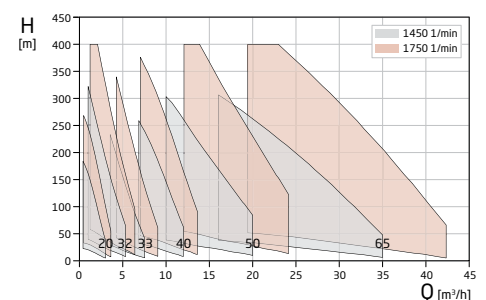

# Centrifugal pumps with magnetic coupling (heat transfer pumps)



Speck is your expert point of contact for the optimal, energy-efficient and safe design of pumps with magnetic couplings.



In its TOE modular system, Speck offers centrifugal pumps with a wide range of variants.

## Features and benefits of the TOEM series

- » Suitable for pure liquids without abrasive contaminants or solid content
- » Centrifugal pumps are particularly well suited for high flow rates at relatively low pressures or total heads
- » Wear-resistant SiC sleeve bearings
- » Low axial thrust thanks to impellers with back vanes

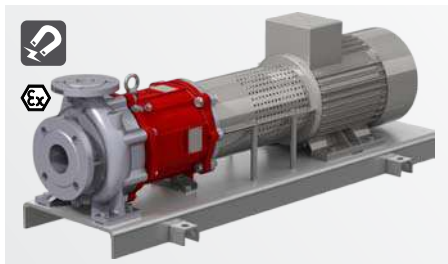

## Series TOEMN

### Centrifugal pumps with magnetic coupling Base plate version

#### Performance range

- » Up to 540/460 m<sup>3</sup>/h and 100 m (50/60 Hz)
- » Spheroidal graphite iron version:  
Thermal oil - 40 °C to + 350 °C
- » Stainless steel version:  
Thermal oil - 100 °C to + 250 °C
- » PN 16

#### Design

- » Magnetic coupling
- » Volute casing (EN 733)
- » Bearing bracket with base plate
- » Spheroidal graphite cast iron/stainless steel

#### Product benefits

- » ATEX II 2G and TA Luft
- » Bearing cooling via fan blade on shaft
- » For larger sizes, balanced sleeve bearing and coupling thanks to centreline mounting and double volute

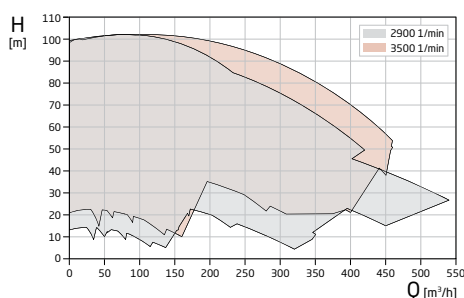

## Series TOEMA

### Centrifugal pumps with magnetic coupling Bracket version

#### Performance range

- » Up to 540/460 m<sup>3</sup>/h and 100 m (50/60 Hz)
- » Spheroidal graphite iron version:  
Thermal oil - 40 °C to + 350 °C
- » Stainless steel version:  
Thermal oil - 100 °C to + 250 °C
- » PN 16

#### Design

- » Magnetic coupling
- » Volute casing (EN 733)
- » Bracket version with optional base plate
- » Spheroidal graphite cast iron/stainless steel

#### Product benefits

- » ATEX II 2G and TA Luft
- » For larger sizes, balanced sleeve bearing and coupling thanks to centreline mounting and double volute

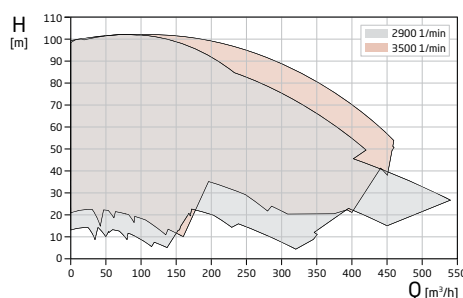

## Series TOEMI

### Centrifugal pumps with magnetic coupling Inline version

#### Performance range

- » Up to 90/110 m<sup>3</sup>/h and 60/85 m (50/60 Hz)
- » Spheroidal graphite iron version:  
Thermal oil - 40 °C to + 350 °C
- » PN 16

#### Design

- » Magnetic coupling
- » Inline casing
- » Bracket version
- » Spheroidal graphite cast iron

#### Product benefits

- » ATEX II 2G and TA Luft
- » Horizontal or vertical installation

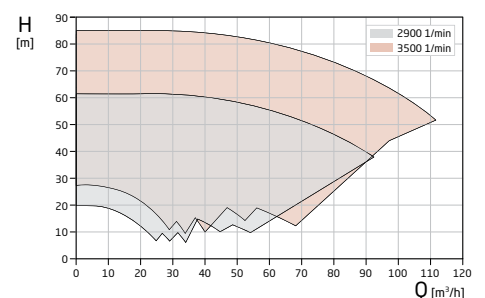



## Regenerative turbine pumps with magnetic coupling

- » At a fixed speed, operating point adjustment by changing the impeller diameter
- » Optimal design for the operating point thanks to a wide range of magnetic couplings
- » Start-up safety device for magnetic couplings with separating cans made of Hastelloy®
- » Optional pump monitoring (sensors) available



Speck is one of the most innovative providers of regenerative turbine pumps in the world and has decades of experience in developing and manufacturing these pumps.



### Series TOEMH

Heat transfer pump with magnetic coupling for media up to 400 °C

#### Performance range

- » Up to 175/185 m<sup>3</sup>/h and 100 m (50 Hz)
- » Oil/media max. 400 °C, e.g., Therminol VP1, Dowtherm A or Syltherm 800
- » PN 40

#### Design

- » Magnetic coupling with ceramic separating can
- » Volute casing (EN 733)
- » Combined bearing bracket/lantern bracket version
- » Cast steel

#### Product benefits

- » ATEX II 2G and TA Luft
- » Part of the TOEG/TOEM modular system
- » No eddy current loss thanks to ceramic separating can

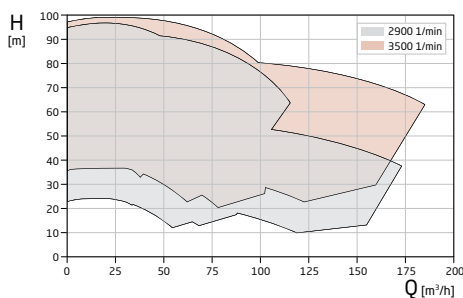

### Series NPY-, AY- and CY-...-MK

Regenerative turbine pumps with magnetic coupling

#### Performance range

- » Up to 200 l/min respectively 12 m<sup>3</sup>/h and 90 m (50/60 Hz)
- » Media from - 100 °C to + 350 °C

#### Design

- » Magnetic coupling
- » Close-coupled design
- » Stainless steel, spheroidal graphite cast iron and special alloys
- » Thread and SAE connections

#### Product benefits

- » ATEX II 2G and TA Luft
- » Ideal for high pressures and/or total heads at relatively low flow rates
- » Suitable for clear or cloudy liquids with cinematic viscosity of up to 100 mm<sup>2</sup>/s without abrasive contaminants or solid content
- » Significantly smaller dimensions in comparison to centrifugal pumps
- » Suitable for the delivery of gas shares
- » Pulsation-free pumping
- » Reversible, i.e., it is possible to change the pumping direction
- » Stable characteristic curves, even in varying operating states

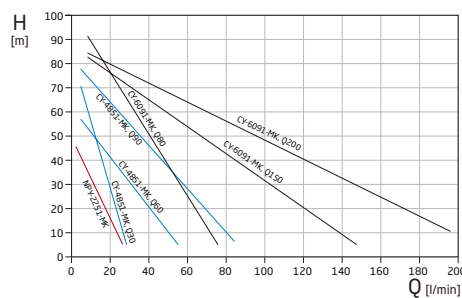

# Centrifugal pumps with mechanical seal (heat transfer pumps)



In its TOE modular system, Speck offers centrifugal pumps with a wide range of variants.

## Features and benefits

- » Suitable for pure liquids without abrasive contaminants or solid content
- » Centrifugal pumps are particularly well suited for high flow rates at relatively low pressures or total heads
- » Wear-resistant SiC sleeve bearings

- » Low axial thrust thanks to impellers with back vanes
- » At a fixed speed, operating point adjustment by changing the impeller diameter
- » Optional pump monitoring (sensors) available

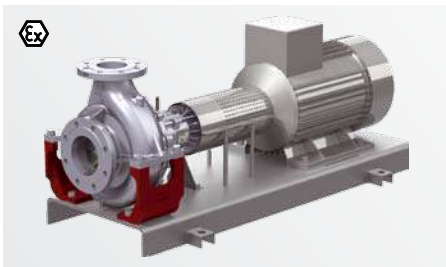

## Series TOEGN

### Centrifugal pumps with mechanical seal - base plate version

#### Performance range

- » Up to 540/460 m<sup>3</sup>/h and 100 m (50/60 Hz)
- » Water up to 160 °C (up to 180 °C upon request)
- » Thermal oil up to 350 °C
- » PN 16

#### Design

- » Single-acting mechanical seal (not cooled)
- » Volute casing (EN 733)
- » Bearing bracket with base plate
- » Spheroidal graphite cast iron

#### Product benefits

- » ATEX II 2G
- » Resistant to low-boilers
- » Bearing cooling via cooling fin and fan blade on shaft
- » For larger sizes, balanced sleeve bearing and coupling thanks to centred housing suspension and double volute

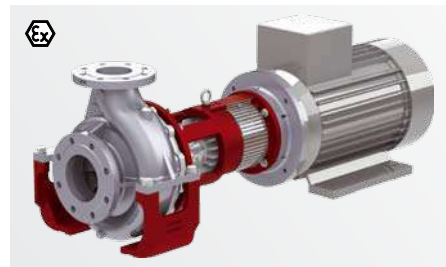
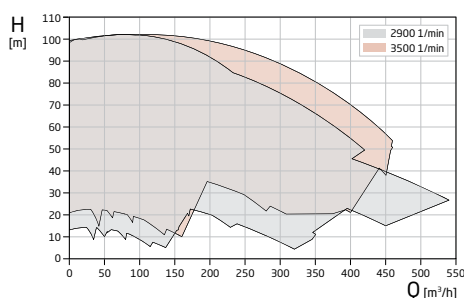

## Series TOEGA

### Centrifugal pumps with mechanical seal - bracket version

#### Performance range

- » Up to 540/460 m<sup>3</sup>/h and 100 m (50/60 Hz)
- » Water up to 160 °C (up to 180 °C upon request)
- » Thermal oil up to 350 °C
- » PN 16

#### Design

- » Single-acting mechanical seal (not cooled)
- » Volute casing (EN 733)
- » Bracket version with optional base plate
- » Spheroidal graphite cast iron

#### Product benefits

- » ATEX II 2G
- » Resistant to low-boilers
- » Bearing cooling via cooling fin and fan blade on shaft
- » For larger sizes, balanced sleeve bearing and coupling thanks to centred housing suspension and double volute

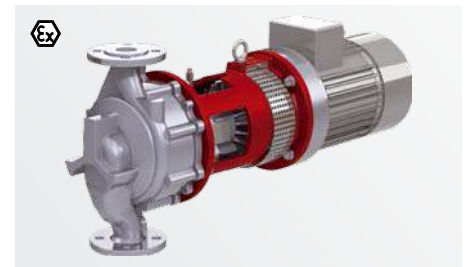
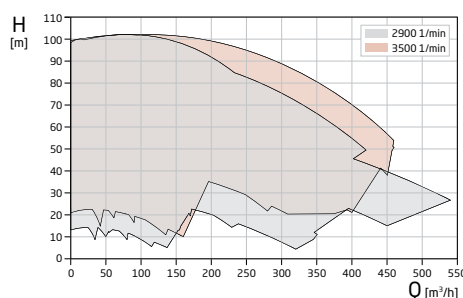

## Series TOEGI

### Centrifugal pumps with mechanical seal - inline version

#### Performance range

- » Up to 90/110 m<sup>3</sup>/h and 60/85 m (50/60 Hz)
- » Water up to 160 °C (up to 180 °C upon request)
- » Thermal oil up to 350 °C
- » PN 16

#### Design

- » Single-acting mechanical seal (not cooled)
- » Inline casing
- » Bracket version
- » Spheroidal graphite cast iron/stainless steel
- » Thermal oil version: Horizontal or vertical installation
- » Hot water version: Horizontal installation

#### Product benefits

- » ATEX II 2G
- » Resistant to low-boilers
- » Bearing cooling via cooling fin and fan blade on shaft

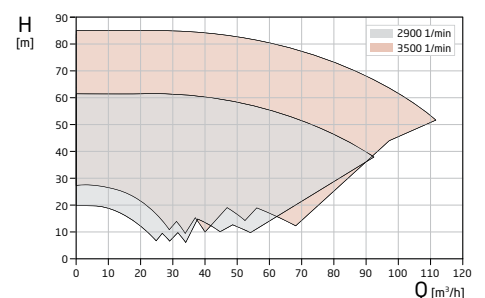

## Centrifugal pumps with mechanical seal



Short pumps in stainless steel or spheroidal graphite cast iron from the TOE modular system for media up to 200 °C.



Multi-stage centrifugal pumps



### Series KNV

Centrifugal pumps with mechanical seal - stainless steel version

#### Performance range

- » Up to 170/185 m<sup>3</sup>/h and 60/85 m (50/60 Hz)
- » Water up to 160 °C
- » Thermal oil up to 200 °C
- » PN 16

#### Design

- » Single-acting mechanical seal
- » Volute casing (EN 733)
- » Bearing bracket with base plate
- » Stainless steel

#### Product benefits

- » Pump casing is part of the TOE modular system
- » Short

### Series KNG

Centrifugal pumps with mechanical seal - spheroidal graphite cast iron version

#### Performance range

- » Up to 180/210 m<sup>3</sup>/h and 100 m (50/60 Hz)
- » Water up to 160 °C
- » Oil up to 200 °C
- » PN 16

#### Design

- » Single-acting mechanical seal
- » Volute casing (EN 733)
- » Bearing bracket with base plate
- » Spheroidal graphite cast iron

#### Product benefits

- » Pump casing is part of the TOE modular system
- » Short

### Series ES

Multi-stage horizontal boiler feed pump with mechanical seal

#### Performance range

- » Up to 110/125 m<sup>3</sup>/h and 400/600 m (50 Hz)
- » Media up to 120 °C
- » PN 40 and PN 63

#### Design

- » Multi-stage centrifugal pump
- » Single-acting mechanical seal or packing gland
- » Grey cast iron/spheroidal graphite cast iron

#### Product benefits

- » Pump for high nominal pressures and large volumes
- » Durable design
- » Long service life and low maintenance costs
- » High operational safety

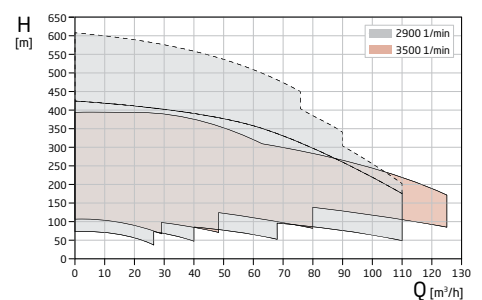
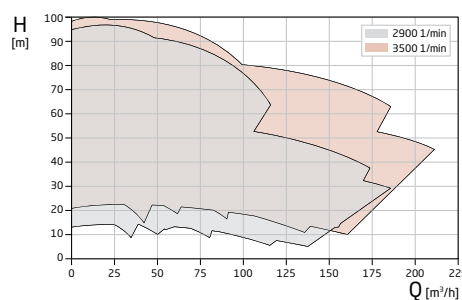
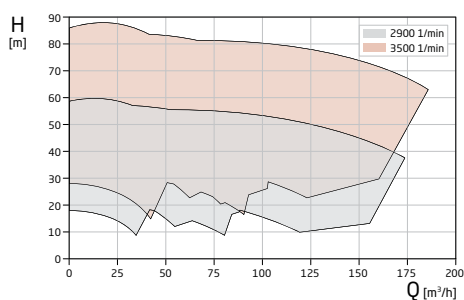



Space for your notes



# Representations

- Produktion / Production
- Vertrieb / Sales
- Service / Service

**■** **Speck Pumpen**  
**Walter Speck GmbH & Co. KG**  
**Speck Pumpen**  
**Systemtechnik GmbH**  
**Speck Pumpen**  
**Vakuumentchnik GmbH**  
 Regensburger Ring 6 - 8, 91154 Roth  
 T: +49 91 71 809 0  
 F: +49 91 71 809 10  
 info@speck.de  
 www.speck.de

**□**  
**Speck Office Nord**  
**Ingenieure Willy Wandrach GmbH**  
 Flurstraße 105  
 22549 Hamburg  
 T: +49 40 398 624 0  
 F: +49 40 398 624 28  
 info@speck-nord.de  
 www.speck-nord.de

**□**  
**Speck Office Mitte**  
 Grotthaus-Steinweg Str. 1c  
 38112 Braunschweig  
 T: +49 531 23 000 90  
 info@speck-mitte.de  
 www.speck-mitte.de

**□**  
**Speck Office West**  
 Robert-Koch-Straße 22  
 40764 Langenfeld  
 T: +49 2173 914 560  
 info@speck-west.de  
 www.speck-west.de

**□**  
**Speck Office Ost**  
 Dahlemer Str. 7a  
 04889 Belgern-Schildau  
 T: +49 34221 557 812  
 info@speck-ost.de  
 www.speck-ost.de

**□**  
**Speck Office Südwest**  
 Frankenstr. 9  
 67227 Frankenthal  
 T: +49 6233 354 80 57  
 info@speck-suedwest.de  
 www.speck-suedwest.de

**○**  
**IVT-Pumpen GmbH**  
 Zum Wischfeld 1 A  
 31749 Auetal  
 T: +49 5752 929 597  
 F: +49 5752 929 599  
 info@ivt-pumpen.de  
 www.ivt-pumpen.de

**○**  
**FSE Fluid Systems Erfurt**  
 Poeler Weg 6  
 99005 Erfurt  
 T: +49 361 550 715 0  
 F: +49 361 550 715 19  
 info@fluidsystems.org  
 www.fluidsystems.org

**○** **Vacuum pumps**  
**Arpuma GmbH**  
 Ottostraße 10  
 50170 Kerpen  
 T: +49 2273 953 300 0  
 F: +49 2273 953 300 20  
 info@arpuma.de  
 www.arpuma.de

## International

**(A) Austria**  
**■** **Tuma Pumpensysteme GmbH**  
 Eitnergasse 12  
 1230 Wien  
 T: +43 191 493 40  
 F: +43 191 414 46  
 contact@tumapumpen.at  
 www.tumapumpen.at

**(AUS) Australia**  
**Speck Pumpen Subsidiary**  
**■** **Speck Industries Pty Ltd.**  
 Unit 2  
 6 Glory Road  
 Gungahra WA 6077  
 T: 1300 207 380  
 T: +61 8 6201 1286  
 sales@speckaustralia.com  
 www.speckaustralia.com

**(B) Belgium**  
*Heat transfer pumps / Pompes pour fluid thermique*  
**■** **FLOWMOTION BVBA**  
 Mergelweg 3  
 1730 Asse  
 T: +32 2 309 67 13  
 F: +32 2 309 69 13  
 info@flowmotion.be  
 www.flowmotion.be

**□** **SPECK - Pompen België N.V.**  
 Bierweg 24  
 9880 Aalter  
 T: +32 937 530 39  
 F: +32 932 900 17  
 info@speckpompen.be  
 www.speckpompen.be

**(BG) Bulgaria**  
**■** **EVROTECH OOD**  
 54 A, Manastirska Str.  
 1111 Sofia  
 T: +359 2 971 32 73  
 F: +359 2 971 22 88  
 office@evrotech.com  
 www.evrotech.com

**(CH) Switzerland**  
**Speck Pumpen Subsidiary**  
**■** **Speck Pumpen Industrie GmbH**  
 Bürglenweg 4  
 8854 Galggenen  
 T: +41 554 425 094  
 F: +41 554 425 094  
 info@speckswitzerland.com  
 www.speckswitzerland.com

**■** **HänyTec AG**  
 Pumpen-Prozesse-Service  
 Lättfeld 2  
 6142 Gettnau  
 T: +41 62 544 33 00  
 F: +41 62 544 33 10  
 contact@haenytec.ch  
 www.haenytec.ch

**■** **MEYER ARMATUREN PUMPEN GMBH**  
 Rigackerstrasse 19  
 5610 Wohlen  
 T: +41 56 622 77 33  
 F: +41 56 622 77 60  
 info@meyer-armaturen.ch  
 www.meyer-armaturen.ch

**(CN) China**  
**Speck Pumpen Subsidiary**  
**■** **Jiashan SPECK PUMPS**  
 Systemtechnik Ltd.  
 No. 57, Hong Qiao Rd., Hulimin Street  
 No. 4 Economical Developing Zone,  
 314100 Jiashan Xian,  
 Zhejiang Province  
 T: +86 573 847 312 98  
 F: +86 573 847 312 88  
 steveche@speck-pumps.cn  
 www.speck-pumps.cn

**(CZ) Czech Republic**  
**■** **Sigmat spol s.r.o.**  
 Kosmonautu c.p. 1103/6a  
 77200 Olomouc  
 T: +420 585 231 070  
 F: +420 585 227 072  
 sigmet@sigmet.cz  
 www.sigmet.cz

**(DK) Denmark**  
**■** **Pumpegruppen a/s**  
 Lundtoftegårdsvej 95  
 2800 Lyngby  
 T: +45 459 371 00  
 F: +45 459 347 55  
 info@pumpegruppen.dk  
 www.pumpegruppen.dk

**(E) Spain**  
**Speck Pumpen Subsidiary**  
**■** **SPECK BOMBAS INDUSTRIALES, S.L.U.**  
 Trafalgar, 53 despacho 6  
 Centro de Negocios CNAF  
 46023 Valencia  
 T: +34 963 811 094  
 F: +34 963 811 096  
 M: +34 618 376 241  
 ventas@speckbombas.es  
 www.speck.de

**(F) France**  
**Speck Pumpen Subsidiary**  
**■** **Speck Pompes Industries S.A.**  
 Z.I. Parc d'Activités du Ried  
 4, rue de l'Energie  
 B.P. 227  
 67727 Hoerdt Cedex  
 T: +33 3 88 68 26 60  
 F: +33 3 88 68 16 86  
 info@speckpi.fr

**(GB) Great Britain**  
**■** **Speck ABC UK Ltd**  
 ArenA House  
 Moston Road,  
 Elworth, Sandbach  
 Cheshire CW11 3HL  
 T: +44 844 764 063 2  
 F: +44 844 764 063 4  
 admin@speck-abc.com  
 www.speck-abc.com

**(GR) Greece**  
**■** **SPECK Hellas**  
 Salaminos St. 54  
 17676 Kallithea  
 T: +30 210 956 500 6  
 F: +30 210 957 747 3  
 grecha@speckhellas.gr

**(I) Italy**  
*Centrifugal pumps / Pompe centrifughe*  
**■** **Speck Industries S.r.l**  
 Via Garibaldi, 53  
 20010 Canegrate (MI)  
 T: +39 0331 405 805  
 M: +39 339 16 59 440  
 info@speckindustries.it  
 www.speckindustries.it

*Vacuum pumps / Pompe per vuoto*  
**■** **Rio Nanta S.r.l.**  
 Via Mauro Macchi, 42  
 20124 Milano  
 T: +39 028 940 642 1  
 F: +39 028 323 913  
 M: +39 339 658 781 6  
 rionanta@rionanta.it  
 www.rionanta.it

**(IL) Israel**  
*Small pumps / heat transfer pumps*  
**■** **Ringel Brothers (1973) Ltd.**  
 134 Hertzel St.  
 P.O. Box 5148  
 Tel-Aviv 66555  
 T: +972 368 255 05  
 F: +972 368 220 41  
 M: +972 544 623 095  
 mringel@ringel-bros.co.il  
 www.ringel-bros.co.il

**(IND) India**  
**■** **Flux Pumps India Pvt. Ltd.**  
 427/A-2, Gultekdi Industrial Estate  
 Near Prabhat Printing Press  
 Pune - 411 047, Maharashtra  
 T: +91 020 2427 1023  
 F: +91 020 2427 0689  
 M: +91 98504 03114  
 kiran.kadam@flux-pumps.in  
 www.flux-pumps.in

**(J) Japan**  
**■** **Rodateq, Inc.**  
 Suite 301 Oka Bldg,  
 2 - 1 - 16 Kiyomachibori, Nishiku  
 550 - 0003 Osaka  
 T: +81 664 441 940  
 F: +81 664 449 050  
 info@rodateq.co.jp  
 www.rodateq.co.jp

**■** **Rodateq, Inc.**  
 Tokyo Branch  
 No. 408, 3 - 22 - 12  
 Highashi Ikebukuro, Toshima - ku  
 170-0013 Tokyo  
 T: +81 359 798 818  
 F: +81 359 798 817  
 roda-t@yo.rim.or.jp  
 www.rodateq.co.jp

**(L) Luxembourg**  
*Heat transfer pumps / Pompes pour fluid thermique*  
**■** **FLOWMOTION BVBA**  
 Mergelweg 3  
 1730 Asse  
 T: +32 2 309 67 13  
 F: +32 2 309 69 13  
 info@flowmotion.be  
 www.flowmotion.be

**(MAL) Malaysia**  
**■** **Leesonmech**  
 Engineering (M) Sdn. Bhd.  
 No. 18 Jalan 18, Taman Sri Kluang,  
 86000 Kluang, Johor  
 T: +607 777 105 5  
 F: +607 777 106 6  
 sales@leesonmech.com  
 www.leesonmech.com

**(N) Norway**  
**■** **PG Flow Solutions AS**  
 P.O.Box 154, 1378 Nesbru  
 Nye Vakaas Vei 14  
 1395 Hvalstad  
 T: +47 667 756 00  
 F: +47 667 756 01  
 post@pg-flowsolutions.com  
 www.pg-flowsolutions.com

**(NL) Netherlands**  
*Centrifugal pumps / Centrifugaalpompen*  
**■** **Speck Pompen Nederland B.V.**  
 Businesspark 7Poort  
 Stationspoort 10  
 6902 KG Zevenaar  
 T: +31 316 331 757  
 F: +31 316 528 618  
 info@speck.nl  
 www.speck.nl

*Vacuum pumps / Vacuümpompen*  
**■** **DOVAC B.V.**  
 Meer en Duin 228  
 2163 HD Lisse  
 T: +31 252 423 363  
 F: +31 252 417 946  
 info@dovac.nl  
 www.dovac.nl

*Heat transfer pumps / Pompes pour fluid thermique*  
**■** **FLOWMOTION BVBA**  
 Mergelweg 3  
 1730 Asse  
 T: +32 2 309 67 13  
 F: +32 2 309 69 13  
 info@flowmotion.be  
 www.flowmotion.be

**(NZ) New Zealand**  
**Speck Pumpen Subsidiary**  
**■** **Speck Industries Pty Ltd.**  
 Unit 2  
 6 Glory Road  
 Gungahra WA 6077  
 T: +61 8 6201 1286  
 sales@speckaustralia.com  
 www.speckaustralia.com

**(P) Portugal**  
**■** **Ultra Controlo**  
 Projectos Industriais, Lda.  
 Quinta Lavi - Armazém 8  
 A-brunheira  
 27 10 - 089 Sintra  
 T: +351 219 154 350  
 F: +351 219 259 002  
 info@ultra-controlo.com  
 www.ultra-controlo.com

**(PL) Poland**  
**■** **Krupinski Pompy Spółka z**  
 Ograniczoną Odpowiedzialnością Sp.k.  
 ul. Przymarki 4A  
 31-764 Krakow  
 T + F: +48 126 455 684  
 biuro@krupinski.krakow.pl  
 www.krupinski.krakow.pl

**(RC) Taiwan**  
**Speck Pumpen Subsidiary**  
**■** **Speck Pumps**  
 Technology Taiwan Ltd.  
 2Fl., no. 153, Sec 2  
 Datong Rd., Xizhi District  
 New Taipei City  
 T: +886 286 926 220  
 F: +886 286 926 759  
 M: +886 936 120 952  
 speck886@ms32.hinet.net  
 www.speck-pumps.com.tw

**(RCH) Chile**  
**■** **W & F Ingeniería Y Maquinas S.A.**  
 Felix de Amesti 90, Piso 6  
 Las Condes, Santiago  
 T: +56 2 220 629 43  
 F: +56 2 220 630 39  
 M: +56 9 8 289 222 0  
 rwendler@wyf.cl  
 www.wyf.cl

**(RI) Indonesia**  
**■** **PT Roda Rollen Indonesia**  
 Kompleks Pertokoan Glodok  
 Jaya No. 30  
 Jl. Hayam Wuruk,  
 Jakarta - Pusat  
 Indonesia, 11180  
 T: +6221 659 922 528  
 F: +6221 380 595 9  
 rudy@rodarollenindonesia.com

**(ROK) Korea**  
**■** **J.C. International Inc.**  
 2F, Bikeum Bldg. 108,  
 Yanghwa-Ro, Mapo-Gu,  
 121-893 Seoul  
 T: +82 232 628 00  
 F: +82 232 569 09  
 jylee@jicint.co.kr  
 www.jicint.co.kr

**(RO) Romania**  
**■** **S.C. Gimsid S.R.L.**  
 Str. Arcului nr. 9, Arp.2  
 021031 Bucuresti  
 T: +40 21 2118701  
 F: +40 21 2102675  
 gimsid@gimsid.ro  
 www.gimsid.ro

**(RUS) Russia**  
**■** **LLC Firm Kreoline**  
 Yunosti str., 5/3  
 Moscow 111395  
 T: +7 495 737 321 4  
 F: +7 495 769 844 0  
 M: +7 495 505 198 8  
 info@kreoline.ru  
 www.kreoline.ru

**(S) Sweden**  
**■** **Hugo Tillquist AB**  
 P.O.Box 1120  
 16422 Kista  
 T: +46 859 463 200  
 F: +46 875 136 95  
 info@tillquist.com  
 www.tillquist.com

**(SK) Slovakian Republic**  
 → Czech Republic (CZ)

**(SLO) Slovenia**  
**■** **SLOTEH Branko Gabric s.p.**  
 Zagrebška cesta 20  
 2000 Maribor  
 T: +38 624 614 460  
 F: +38 624 614 465  
 branko.gabric@gamis.net  
 www.sloteh.si

**(SGP) Singapore**  
 → Malaysia (MAL)

**(T) Thailand**  
**Speck Pumpen Subsidiary**  
**■** **Pump Systems Flux & Speck Co. Ltd.**  
 181/4 Soi Anamai  
 Srinakarin Road  
 Suanluang Bangkok 10250  
 T: +662 320 256 7  
 F: +662 322 248 6  
 thienchai@fluxspeck.com  
 www.fluxspeck.com

**(TR) Turkey**  
**■** **Speck Pompa**  
 San. ve Tic. Ltd. Sti.  
 Girm. Mah., Küçükyalı Is Merkezi  
 B Blok No.12 Maltepe  
 34852 Istanbul  
 T: +90 216 375 750 5  
 F: +90 216 375 753 3  
 M: +90 532 293 010 4  
 speck@speckpompa.com.tr  
 www.speckpompa.com.tr

**(USA) USA**  
**Speck Pumpen Subsidiary**  
**■** **Speck Industries LP**  
 301 Veterans Blvd  
 Rutherford  
 NJ 07070  
 T: +1 201 569 3114  
 F: +1 201 569 9607  
 info@speckamerica.com  
 www.speckamerica.com

**(ZA) Rep. South Africa**  
**■** **SPP Pumps SA (Pty) Ltd.**  
 Cnr Horne St & Brine Ave  
 Chloorkop Ext 23  
 Kempton Park  
 1619 Gauteng  
 R.S.A.  
 1619  
 T: +27 11 393 7177  
 F: +27 86 513 0255  
 sales@sppumps.co.za  
 www.sppumps.co.za



Speck Pumpen Walter Speck GmbH & Co. KG  
Speck Pumpen Systemtechnik GmbH  
Speck Pumpen Vakuumtechnik GmbH  
Regensburger Ring 6 - 8 · 91154 Roth, Germany  
T: +49 9171 809 0  
F: +49 9171 809 10  
info@speck.de  
www.speck.de